

Соединительные фитинги. Присоединительные резьбы от М5 до G1".

Артикул 104

Переходник, Нр-Вн

Никелированная латунь

Код	A	B	C	D			
1041418	R1/4"	G1/8"	11,0	16,0		14	100
1043818	R3/8"	G1/8"	11,5	16,5		17	100
1041218	R1/2"	G1/8"	14,0	19,5		22	50
1043814	R3/8"	G1/4"	11,5	16,5		17	100
1041214	R1/2"	G1/4"	14,0	19,5		22	50
1041238	R1/2"	G3/8"	14,0	19,5		22	50
1043438	R3/4"	G3/8"	16,5	23,5		27	50
1043412	R3/4"	G1/2"	16,5	23,5		27	25
1040112	R1"	G1/2"	17,0	25,0		34	25
1040134	R1"	G3/4"	17,0	25,0		34	25

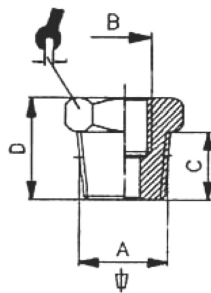

Артикул 104z

Переходник, Нр-Вн

Никелированная латунь

Код	A	B	C	D			
104z18M5	G1/8"	M5	6,0	10,5		14	100
104z1418	G1/4"	G1/8"	8,0	13,0		17	100
104z3818	G3/8"	G1/8"	9,0	14,0		19	100
104z3814	G3/8"	G1/4"	9,0	14,0		19	100
104z1218	G1/2"	G1/8"	10,0	15,5		24	50
104z1214	G1/2"	G1/4"	10,0	15,5		24	50
104z1238	G1/2"	G3/8"	10,0	15,5		24	50
104z3438	G3/4"	G3/8"	12,5	18,0		27	25
104z3412	G3/4"	G1/2"	12,5	18,0		27	25

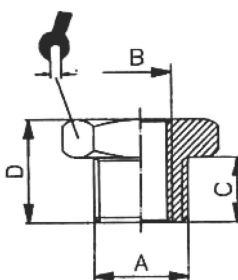

Артикул 105

Переходник, Нр-Вн

Никелированная латунь

Код	A	B	C	D			
1051818	R1/8"	G1/8"	8,0	20,0		14	100
1051814	R1/8"	G1/4"	8,0	22,5		17	100
1051838	R1/8"	G3/8"	8,0	25,0		22	50
1051414	R1/4"	G1/4"	11,0	25,0		17	100
1051438	R1/4"	G3/8"	11,0	27,0		22	50
1051412	R1/4"	G1/2"	11,0	31,5		24	50
1053838	R3/8"	G3/8"	11,5	27,5		22	50
1053812	R3/8"	G1/2"	11,5	32,0		24	25
1051212	R1/2"	G1/2"	14,0	34,0		24	25
1051234	R1/2"	G3/4"	14,0	35,0		30	25

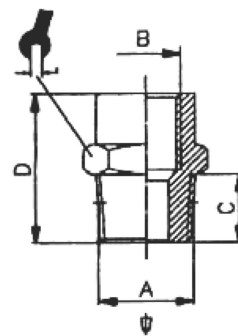

Артикул 105z

Переходник, Нр-Вн

Никелированная латунь

Код	A	B	C	D			
105zM5M5	M5	M5	4,0	10,5		8	100
105zM518	M5	G1/8"	4,0	15,5		14	100
105z1818	G1/8"	G1/8"	6,0	16,5		14	100
105z1814	G1/8"	G1/4"	6,0	20,5		17	100
105z1838	G1/8"	G3/8"	6,0	23,0		22	50
105z1414	G1/4"	G1/4"	8,0	22,0		17	100
105z1438	G1/4"	G3/8"	8,0	24,0		22	50
105z1412	G1/4"	G1/2"	8,0	28,5		26	50
105z3838	G3/8"	G3/8"	9,0	25,0		22	50
105z3812	G3/8"	G1/2"	9,0	29,5		24	25
105z1212	G1/2"	G1/2"	10,0	30,5		24	25

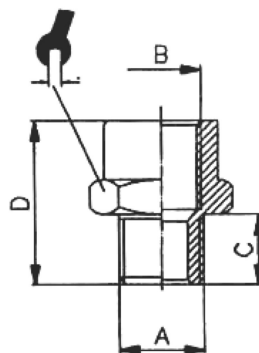

Соединительные фитинги. Присоединительные резьбы от М5 до G1".

Артикул 106 Соединитель, Вн-Вн Никелированная латунь

Код	A	B	C				
106M518	M5	G1/8"	13,5			14	100
1061814	G1/8"	G1/4"	19,0			17	100
1061838	G1/8"	G3/8"	20,0			22	25
1061812	G1/8"	G1/2"	24,0			24	50
1061438	G1/4"	G3/8"	23,0			22	50
1061412	G1/4"	G1/2"	25,0			24	50
1063812	G3/8"	G1/2"	27,5			24	50
1061234	G1/2"	G3/4"	30,0			32	20
1061201	G1/2"	G1"					10
1063401	G3/4"	G1"					10

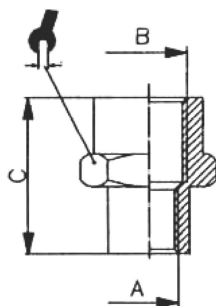

Артикул 107 Заглушка с уплотнительным кольцом Никелированная латунь

Код	A	P	L	ØE			
107M5	M5	4,0	5,5	8,0		2,5	100
10718	G1/8"	6,0	8,0	14,0		4,0	100
10714	G1/4"	8,0	10,0	17,0		6,0	100
10738	G3/8"	9,0	12,0	20,0		8,0	100
10712	G1/2"	11,0	14,0	24,0		10,0	50

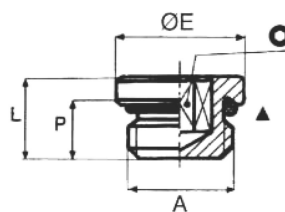

Артикул 107z Заглушка Никелированная латунь

Код	A	B	C				
107z18	G1/8"	6,0	10,5			14	100
107z14	G1/4"	8,0	13,0			17	100
107z38	G3/8"	9,0	14,0			19	50
107z12	G1/2"	10,0	15,5			24	50
107z34	G3/4"	11,0	16,5			30	25
107z01	G1"	13,0	19,0			38	10

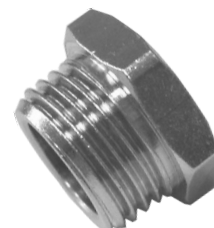
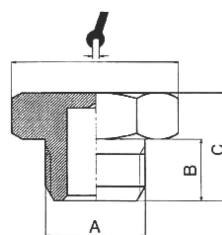

Артикул 108 Заглушка с внутренней резьбой Никелированная латунь

Код	A	I	H	ØL			
10818	G1/8"	7,0	13,0	11,8		12	100
10814	G1/4"	8,0	16,0	16,8		14	100
10838	G3/8"	10,0	20,0	19,8		17	50
10812	G1/2"	11,0	23,5	23,8		24	50

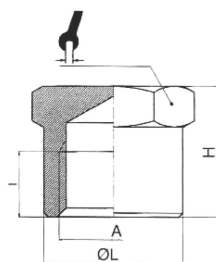

Артикул 109 Уголок, Вн-Вн Никелированная латунь

Код	A	B	C				
10918	G1/8"	7,0	20,0			10	100
10914	G1/4"	8,0	25,5			13	50
10938	G3/8"	10,0	29,0			17	25
10912	G1/2"	11,0	36,0			20	20
10934	G3/4"	16,0	36,0			25	5
10901	G1"	19,0	44,0			30	5

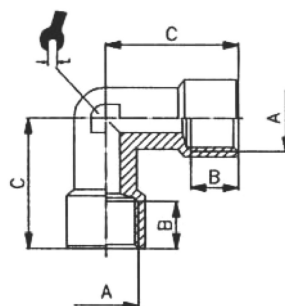

Соединительные фитинги. Присоединительные резьбы от М5 до G1".

Артикул 110

Уголок, Нр-Вн

Никелированная латунь

Код	A	A1	B	B1	C	D		
110M5	M5	M5	4,0		11,0	11,5	9	100
11018	G1/8"	R1/8"	7,0	8,0	20,0	19,0	10	50
11014	G1/4"	R1/4"	8,0	11,0	25,5	24,0	13	50
11038	G3/8"	R3/8"	10,0	11,5	29,0	26,5	17	25
11012	G1/2"	R1/2"	11,0	14,0	35,0	31,5	20	20
11034	G3/4"	R3/4"	16,0	16,0	35,0	34,5	25	5
11001	G1"	R1"	19,0	16,0	44,0	51,0	30	5
11014F18M	G1/4"	R1/8"	8,0	8,0	25,5	23,0	13	50
11014M18F	G1/8"	R1/4"	7,0	11,0	20,0	26,0	10	50

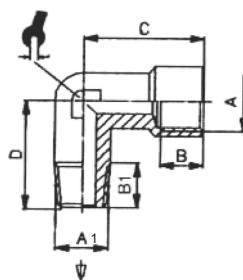

Артикул 115

Уголок, Нр-Нр

Никелированная латунь

Код	A	A1	B	C			
11518	R1/8"	R1/8"	8,0	19,0		10	100
11514	R1/4"	R1/4"	12,5	24,0		13	50
11538	R3/8"	R3/8"	13,6	26,5		17	25
11512	R1/2"	R1/2"	15,5	31,5		20	25
11534	R3/4"	R3/4"	15,0	35,5		25	5
11501	R1"	R1"	16,0	51,0		30	5
1151814	R1/8"	R1/4"	8,0	22,0		13	50

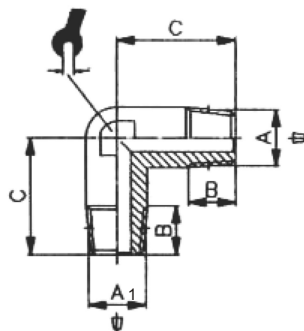

Артикул 111

Тройник, Вн-Вн-Вн

Никелированная латунь

Код	A	B	C	D			
11118	G1/8"	7,0	20,0	40,0		10	50
11114	G1/4"	8,0	25,5	51,0		13	25
11138	G3/8"	10,0	29,0	58,0		17	20
11112	G1/2"	11,0	35,0	70,0		20	10
11134	G3/4"	16,0	31,0	73,0		25	5
11101	G1"	19,0	49,5	90,0		30	5

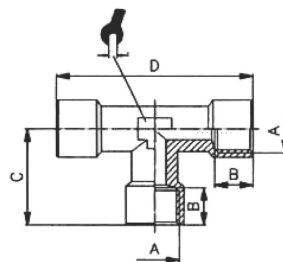

Артикул 112

Тройник, Вн-Нр-Вн

Никелированная латунь

Код	A	B	B1	C	D		
11218	R1/8"	7,0	8,0	19,0	40,0	10	50
11214	R1/4"	8,0	11,0	24,0	51,0	13	25
11238	R3/8"	10,0	13,6	26,5	58,0	17	25
11212	R1/2"	11,0	15,5	31,5	72,0	20	10
11234	R3/4"	16,0	15,0	31,0	73,0	25	5
11201	R1"	19,0	16,0	38,0	90,0	30	5

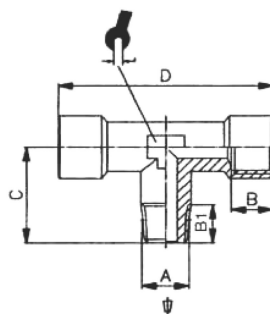

Артикул 113

Тройник, Нр-Вн-Вн

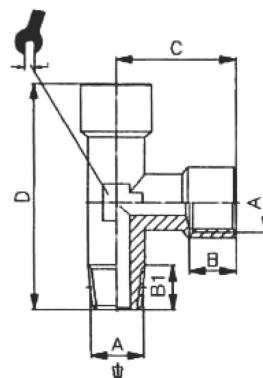

Никелированная латунь

Код	A	A1	B	B1	C	D		
11318	R1/8"	G1/8"	7,0	8,0	20,0	39,0	10	50
11314	R1/4"	G1/4"	8,0	11,0	25,5	49,5	13	25
11338	R3/8"	G3/8"	10,0	13,6	29,0	55,5	17	25
11312	R1/2"	G1/2"	11,0	15,5	35,0	65,0	20	10
11334	R3/4"	G3/4"	16,0	15,0	31,0	67,0	25	5
11301	R1"	G1"	19,0	16,0	44,0	84,0	30	5





Соединительные фитинги. Присоединительные резьбы от М5 до G1”.

Артикул 116
Тройник, Нр-Нр-Нр
Никелированная латунь

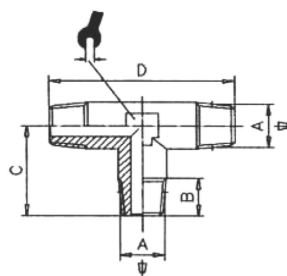
Код	A	B	C	D			
11618	R1/8”	8,0	19,0	38,0		10	100
11614	R1/4”	12,5	24,0	48,0		13	50
11638	R3/8”	13,6	26,5	53,0		17	25
11612	R1/2”	15,5	31,5	63,0		20	10
11634	R3/4”	15,0	35,5	66,0		25	5
11601	R1”	16,0	40,5	78,0		30	5



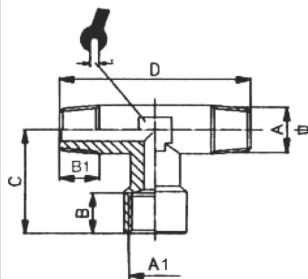

Артикул 117
Тройник, Нр-Вн-Нр
Никелированная латунь

Код	A	A1	B	B1	C	D			
11718	R1/8”	G1/8”	7,0	8,0	20,0	38,0		10	100
11714	R1/4”	G1/4”	8,0	12,5	25,5	48,0		13	50
11738	R3/8”	G3/8”	10,0	13,6	29,0	53,0		17	25
11712	R1/2”	G1/2”	11,0	15,5	36,0	63,0		20	10
11734	R3/4”	G3/4”	16,0	15,0	34,5	66,0		25	5
11701	R1”	G1”	19,0	16,0	46,5	78,0		30	5



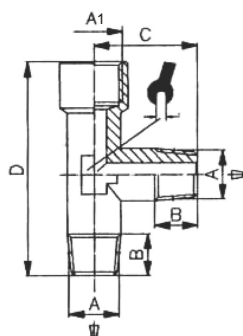

Артикул 118
Тройник, Нр-Нр-Вн
Никелированная латунь

Код	A	A1	B		C	D			
11818	R1/8”	G1/8”	8,0		19,0	39,0		10	100
11814	R1/4”	G1/4”	12,5		24,0	49,5		13	50
11838	R3/8”	G3/8”	13,6		26,5	55,5		17	25
11812	R1/2”	G1/2”	15,5		31,5	67,5		20	10
11834	R3/4”	G3/4”	15,0		34,5	69,0		25	5
11801	R1”	G1”	16,0		38,0	84,0		30	5



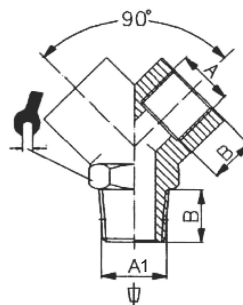

Артикул 125
Тройник, Тип “У”, Вн-Нр-Вн
Никелированная латунь

Код	A1	A	B					
12518	R1/8”	G1/8”	8,0				13	50
12514	R1/4”	G1/4”	11,0				17	25
12538	R3/8”	G3/8”	11,5				20	25
12512	R1/2”	G1/2”	14,0				25	10



Артикул 126
Тройник, Тип “У”, Вн-Вн-Вн
Никелированная латунь

Код		A	B					
12618		G1/8”	8,0				13	50
12614		G1/4”	11,0				17	25
12638		G3/8”	11,5				20	25
12612		G1/2”	14,0				25	10

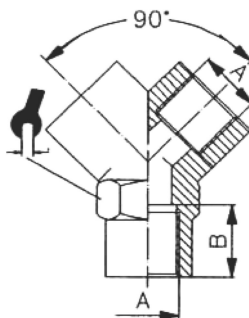

Соединительные фитинги. Присоединительные резьбы от М5 до G1".

Артикул 114 Четвертник, Вн-Вн-Вн-Вн Никелированная латунь

Код	A	B	C				
11418	G1/8"	7,0	40,0			10	25
11414	G1/4"	8,0	51,0			13	25
11438	G3/8"	10,0	58,0			17	10
11412	G1/2"	11,0	72,0			20	5

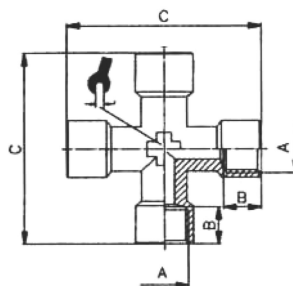

Артикул 120 Четвертник, Нр-Вн-Вн-Вн Никелированная латунь

Код	A1	A	B	B1	C	D				
12018	R1/8"	G1/8"	7,0	8,0	19,0	40,0			10	25
12014	R1/4"	G1/4"	8,0	12,5	24,0	51,0			13	25
12038	R3/8"	G3/8"	10,0	13,6	26,5	58,0			17	10
12012	R1/2"	G1/2"	11,0	15,5	31,5	72,0			20	5

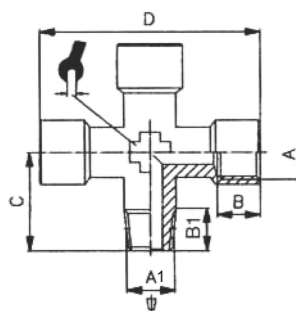

Артикул 128 Четвертник, Нр-Нр-Нр-Нр Никелированная латунь

Код	A	B	C				
12818	R1/8"	8,0	38,0			10	25
12814	R1/4"	12,5	48,0			13	25
12838	R3/8"	13,6	53,0			17	10
12812	R1/2"	15,5	63,0			20	5

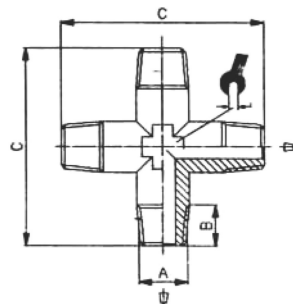

Артикул 119 Штуцер под шланг; с уплотнительным кольцом Никелированная латунь

Код	ØD	A	I	H				
1190718	7,0	G1/8"	6,0	31,5			13	100
1190714	7,0	G1/4"	8,0	34,0			16	100
1190818	8,0	G1/8"	6,0	31,5			13	100
1190918	9,0	G1/8"	6,0	31,5			13	100
1190914	9,0	G1/4"	8,0	34,0			16	100
1190938	9,0	G3/8"	9,0	35,0			17	50
1191018	10,0	G1/8"	6,0	31,5			13	50
1191014	10,0	G1/4"	8,0	34,0			16	50
1191038	10,0	G3/8"	9,0	35,0			17	50
1191214	12,0	G1/4"	8,0	34,0			16	50
1191238	12,0	G3/8"	9,0	36,0			17	50
1191212	12,0	G1/2"	11,0	37,0			22	50
1191738	17,0	G3/8"	9,0	36,0			17	50
1191712	17,0	G1/2"	11,0	37,0			22	50
1191812	18,0	G1/2"	11,0	37,0			22	50

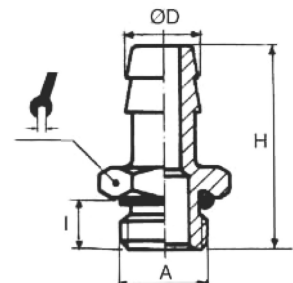

Соединительные фитинги.
Присоединительные резьбы от М5 до G1”.

Артикул 127

Соединитель с монтажной гайкой

Никелированная латунь

Код	G	A	B	C	L	1	2	
127M5	M5	M10x1	10,5	14,0	14,0	14	14	100
12718	G1/8"	M16x1,5	14,0	18,0	22,0	22	19	100
12714	G1/4"	M20x1,5	21,0	25,0	27,0	27	24	50
12738	G3/8"	M26x1,5	21,0	26,0	32,0	32	30	25
12712	G1/2"	M28x1,5	27,0	33,0	36,0	36	32	25

